

Audible Effects of Mechanical Resonances in Turntables



Paper presented at the AES Convention in New York, 1977

Audible effects of mechanical resonances in turntables

by Poul Ladegaard, Brüel & Kjær

Introduction

For many years now, it has been one of a Hi-Fi enthusiasts liberties to choose and combine all the elements in his sound system with only price and personal taste as limiting factors. Therefore, integrated receivers and factory tailored Hi-Fi systems have only had little appeal to the serious Hi-Fi consumer. Naturally, manufacturers of top-grade equipment have sensed that trend and offer products in as small parts as reasonable, to allow greater flexibility for the consumer when building up his system.

Unfortunately, one of the most important factors in getting good sound quality from a system is that the various elements interface well with each other. To ensure that, requires both insight and experience that most Hi-Fi buyers simply do not have.

It is not uncommon, therefore, to see Hi-Fi systems put together by choosing the most advanced and best equipment in each group come out with only an average sound quality.

From our experience, the construction of a good turntable from an individual motor, tonearm and cartridge is one of the most demanding tasks in this respect. This is of course due to the many complex interface problems involved.

Moreover, most manufacturers have serious troubles with this, one reason being that only very few



The measuring set up

manufacturers run a production which incorporates all three important parts. Among them only a couple have realized the interface problems and tried to solve them. However, the results from those firms who have, are so impressive, that they really show where to gain improvements.

In this paper we shall try to see how these interface problems in reality govern both the objectively measured and subjectively evaluated parameters. It is shown how specifications like rumble and wow and flutter, when measured the tra-

ditional way tell us virtually nothing about what they are supposed to do — the motor. Likewise, the preset tracking force with the tonearm in stand-by condition has very little to do with the values found under actual playing conditions.

Other factors not yet subject to standard measurement techniques seem to have a strong influence on the total sound quality. This is the result of spurious mechanical resonances in the tonearm itself, in the chassis structure and the platter, mat, record interface. This latter problem will also be dealt with.

The mechanical resonances

A turntable consists, in principle, of a rotating platter and a fixture for the cartridge. The purpose of this is to give the record groove a velocity, relative to the cartridge diamond, which is precisely $33\frac{1}{3}$, 45 or 78 rpm. The support for the cartridge has only the purpose of keeping the diamond in a constant and steady contact with the groove. This, in such a way, that the force between the needle and groove at all times has the same, pre-determined, magnitude and direction.

This sounds quite simple in theory but in practice one has to deal with mechanical parts which are not perfectly stiff and non-flexing due both to economical and technical reasons. The flexing of the various mechanical parts in the turntable seriously disturb both of the above mentioned requirements for a turntable. The actual places where

flexing can occur are indicated with small springs in Fig. 1.

If we take a look at these compliances, all of them, except one, can in theory, be avoided. The flexing in the tonearm itself and its fixture to the platter can be avoided by the proper choice of materials. It is not as easy to kill resonances in the turntable platter, its mat and the record itself. However, improvements can be achieved by proper design.

The only one which in principle cannot be removed is the compliance between the needle cantilever and the cartridge body, which unfortunately seems to be the most troublesome.

In the first part of the paper we shall only deal with this and see how it affects the standard specifications of a turntable and the audible quality. Resonances in the cartridge itself will not be treated in this text.

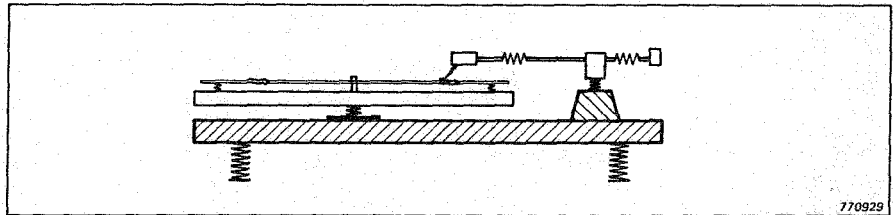

Fig. 1. Sketch of the placement of elastic couplings between the various parts in a turntable. The compliance of these couplings builds up resonances which disturbs the relative position between the cartridge needle and the record groove. This results in deterioration of the sound quality

Part I

The fundamental tonearm resonance

Recent cartridges have been constructed so that they are able to track modern recordings at a tracking force in the range around 10 mN. To achieve this at low frequencies, it is required that the compliance in the cantilever suspension be relatively high, usually around $35 - 50 \mu\text{m}/\text{mN}$.

This compliance together with the effective mass of the tonearm-cartridge combination determines the fundamental tonearm resonance, see Fig. 2. The calculation of the resonance frequency follows simply from

$$f_{res} = \frac{1}{2\pi\sqrt{C(m+M)}}$$

Here M and m are the effective masses of the tonearm and cartridge respectively, both referred to the stylus tip. C is the compliance in the cantilever suspension.

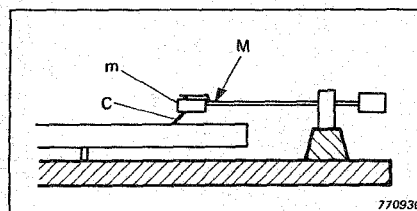

Fig. 2. The fundamental tonearm resonance is determined by the compliance C in the cartridge and the effective mass of the cartridge m and the tonearm M . Both referred to the needle tip

This resonance of course, causes a boost in the frequency response which has an amplitude dependent on the amount of damping in the system.

It is a relatively simple matter to measure this. The set-up is shown in Fig. 3. It uses the B & K test record QR 2010 which has a laterally cut frequency sweep from 5 — 20 Hz.

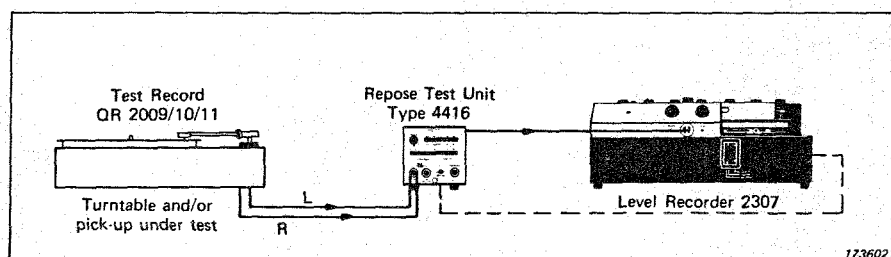

Fig. 3. Set-up for measuring the fundamental tonearm resonance of a turntable

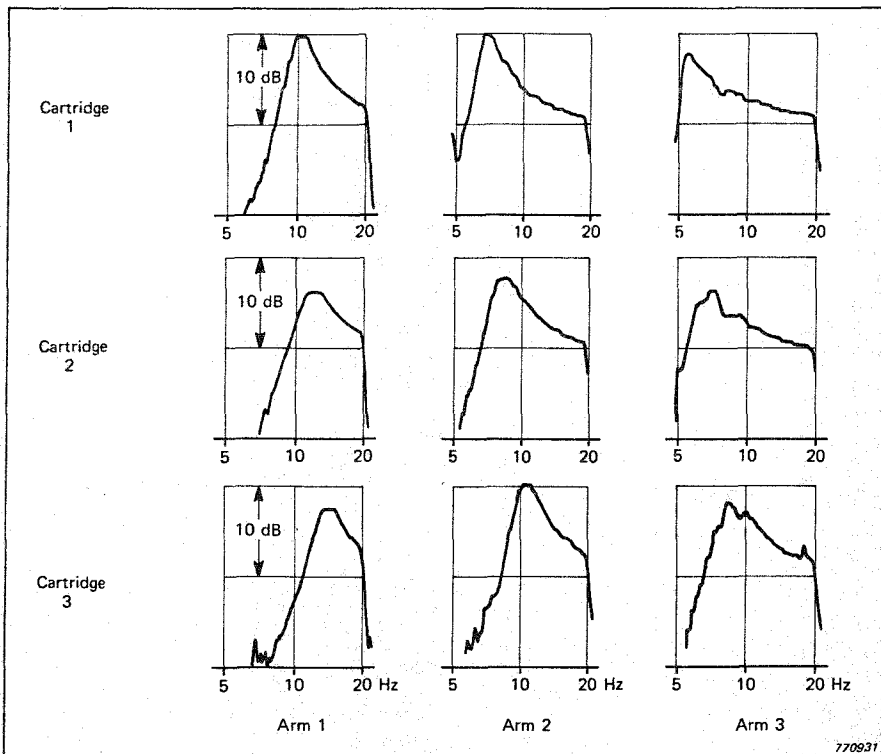

Fig.4. At first sight these curves look rather irrelevant since they do not alter the frequency response in the audible range. The indirect consequences are on the other hand severe, giving rise to measured rumble, wow and flutter and tracking problems

Three arms combined with three different cartridges

As already mentioned, the fundamental tonearm resonance depends solely on the compliance of the cartridge and the effective mass of the tonearm and cartridge, i.e. the actual combination.

To see how this affects the var-

ious parameters we have chosen three cartridges and combined them with three arms of different construction and effective mass. They were mounted on the same turntable while measurements were carried out.

As the examples shown in Fig.4 indicate, there is, at first sight no

reason for suspecting any of these to cause trouble in the audible range. For instance, the frequency response in the range 20 — 20000 Hz is essentially unaffected. But as we will show in the following, the actual size and frequency of this resonance strongly affects parameters as rumble, wow and flutter and the tracking force.

As pointed out by e.g. Peter Rother, (Ref.1) and Happ and Karlow (Ref.2), the optimum tonearm resonant frequency must lie around or slightly above 10 Hz. To try to give a realistic evaluation of the side effects of this suggested optimum tonearm resonance, we have for the following sections in the paper only used cartridge nr. 3, which fulfills the mentioned criteria in each of the three arms. See Fig.4.

However, it must be pointed out that the cartridge nr. 3 has an untypically low compliance, and Arm nr. 1 an unusual low effective mass (below 2,5 grams). This leaves combinations Arm 2 and 3 with cartridge 1 and 2 as representative for the actual situation, with arm resonances around 5 — 8 Hz. The influence in negative direction on both measured and subjectively perceived rumble, flutter tracking is much more aggravated than the following results might indicate. See e.g. the measurements on an "average" turntable Figs. 11 and 18.

Rumble

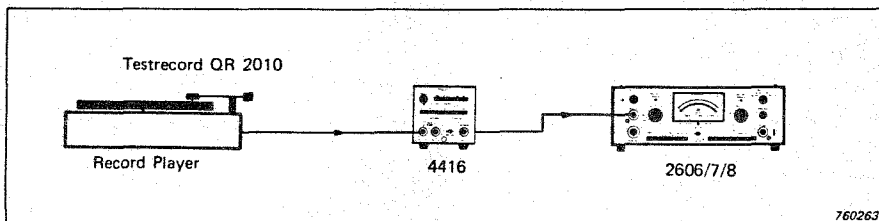

Fig.5. Basic set-up for measuring rumble in a turntable

The standard way of measuring rumble is to use the set-up shown in Fig.5. The response test unit B & K 4416, is equipped with two weighting networks A and B in accordance to the standards. The filter characteristics are shown in Fig.6.

The rapidly increasing standard in the quality of modern turntable motors — better main bearings, direct drive and belt drive systems with effectively decoupled motors — has made it very difficult for the manufacturer to specify useful rumble fi-

gures for turntables. If he uses the weighting filter B it is possible to reach values in the vicinity of 65 dB. This is in fact so close to the background noise from the cartridge and preamplifier that this measurement tells him very little about the quality of the turntable. If, on the other hand, he switches to filter A the figure may show up around 30 dB. Is this then rumble? The answer is no. If he changes to another tonearm or cartridge it may now decrease to 50 dB. How confusing results one can get is shown in Table 1 where we have listed the A and B rumble readings measured on the same turntable and cartridge but with three different arms.

To explain this, the results shown in Fig.4 come out as useful. In the area around 5 — 20 Hz, the cartridge response as shown is not at all linear so the total weighting function is the combination of the curves shown in Fig.4 and curve A in Fig.6. But how can this give such a great difference as reflected by the figures in Table 1? The reason is that records, also good test records, have been through the same pressing process as normal ones. This means that they contain a large amount of "rubbish" from the manufacturing process. Harpp and Karlow (Ref.2) have shown that these sub-audible components have an amplitude distribution which peaks at around 3 — 4 Hz (Fig.7).

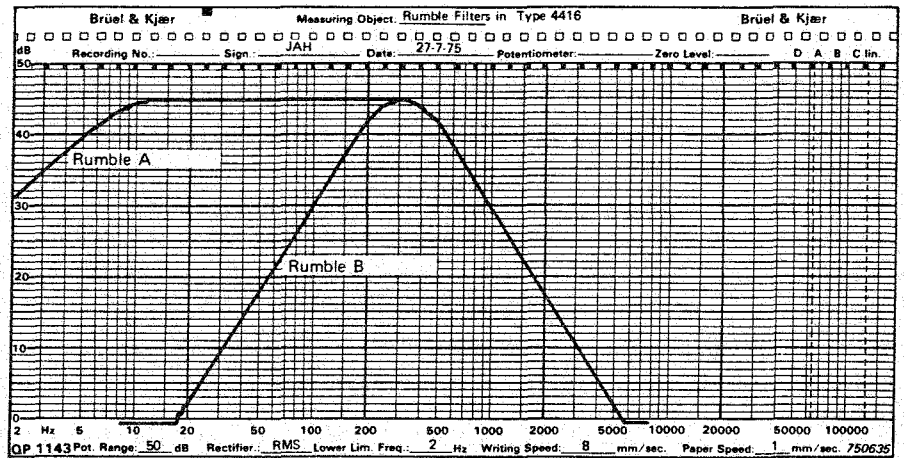

Fig.6. Standard weighting networks A and B for rumble measurements

Therefore, what we measure with rumble filter A also has very little to do with the rumble caused by irregularities in the motor. It is mostly subsonic surface irregularities in the record boosted by the arm resonance.

| | Arm 1 | Arm 2 | Arm 3 |
|----------|-------|-------|-------|
| Rumble A | 38 dB | 28 dB | 22 dB |
| Rumble B | 58 dB | 58 dB | 56 dB |

770932

Table 1. Rumble figures measured with B & K Type 2010 test record (ref. 10 cm/s at 1 kHz left channel). Note the strong dependence of the actual arm used on the A-weighted results

Therefore the record chosen for the rumble measurement has a great influence on the results. In Fig.8 we have on the Narrow Band Analyzer B & K 2031 rumble spectra from three different test records. The standardized DIN test record, the B & K QR 2010 and a Laguer record. The results here reflect both a different content of subsonic noise and irregularities in the record and how it excites the tonearm resonance.

If one really wants to know what the rumble is from, it is necessary to make an analysis. With the B & K Heterodyne Analyzer 2010 in the set-up shown in Fig.9 we have obtained the results shown in Fig.10.

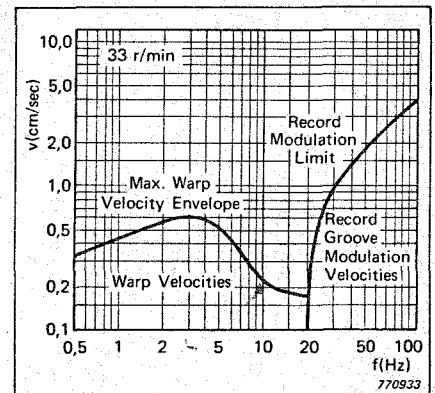
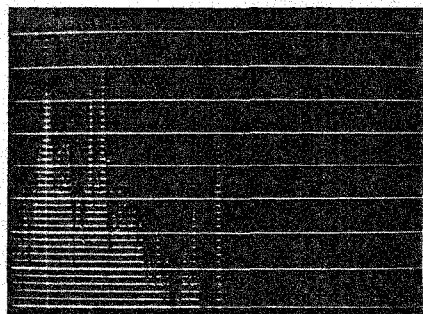
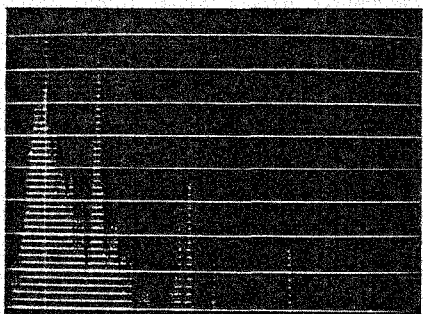

Fig.7. Velocity spectrum of phonograph records



0 B & K QR 2010 100 Hz



0 Lacquer record 100 Hz

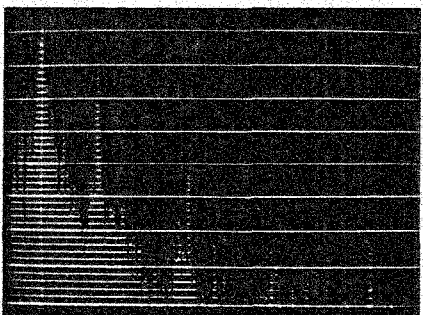

0 DIN 45545 100 Hz

Fig.8. Unweighted rumble spectra from three different test records shown on B & K 2031. Arm number 3 was used

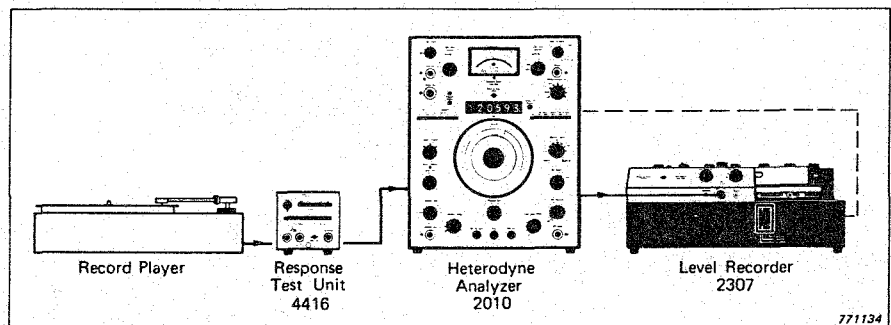

Fig.9. Set-up for making narrow band analysis of rumble using Heterodyne Analyzer Type 2010

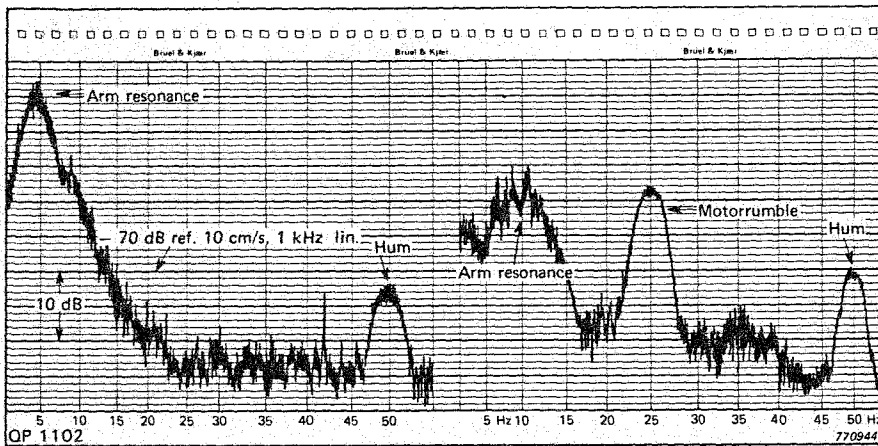

Fig.10. Some typical results from the measurements made with the equipment shown in Fig.9

It is now easy for both the manufacturer and user to see how to improve things. The motor rumble components are a job for the manufacturer to handle, while the boost around the arm resonance can be removed, or at least decreased by a proper choice of arm/cartridge combination. The hum component around 50 Hz can usually be solved by the user by re-arranging ground connections etc.

A much more elegant and fast way of getting the rumble spectrum is the use of parallel analyzers such as B & K 2131 and B & K 2031. In Fig.11 we have on the 1/3 Octave Real Time Analyzer 2131 shown the rumble spectrum of a standard turntable when playing the test record QR 2011. On side 2 the record contains 1/3 octave filtered pink noise intended for use in loudspeaker tests. Fig.11 now shows the rumble level with the measuring signal, a band of 1/3 octave noise at 1 kHz as reference.

Since our ears do not detect sound much below 20 Hz, one could ask: Why then bother about this subsonic "rubbish"? The answer is simply that there are no direct audible effects of that, and if there were, it is a simple matter to install a high pass filter, with a cut-off around 20 Hz.

What then about the indirect effects? Well, the physical meaning of a resonance is increased amplitudes of the relative movements between the record surface and cartridge and, in addition, the lower the frequency the greater the amplitude. Therefore, all the time the cartridge will oscillate at the tonearm resonance with large excursions — just the prescription for making intermodulation distortion on tones in the audible band. Remember, both the rubber suspension in the cartridge and the preamplifier are not linear for large amplitudes. The first thing done in an RIAA preamplifier is to boost the low frequencies by 20 dB.

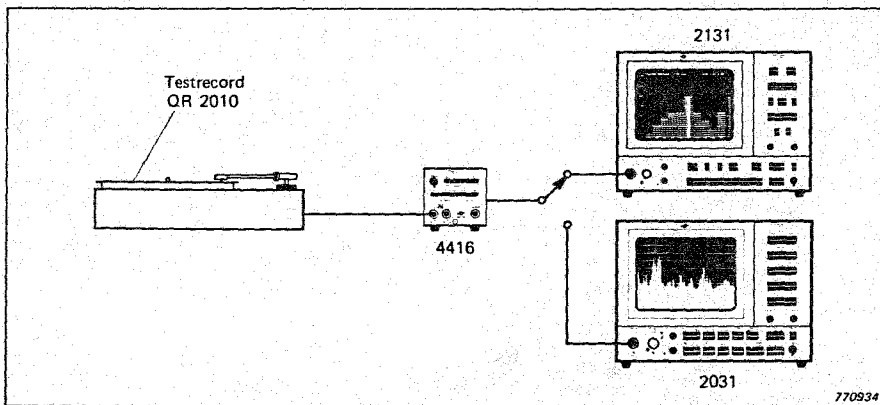
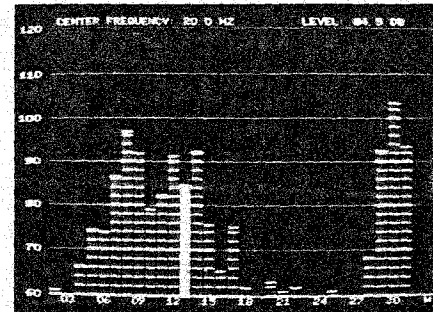
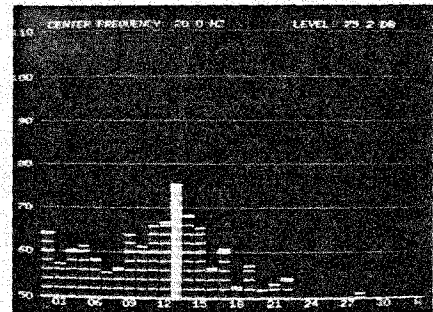

Fig.13. Set-up for measurement of rumble using Parallel Analyzers B & K Type 2031 or 2131



1,6 Hz Standard tonearm 1,25 kHz

Fig.11. Unweighted rumble — spectrum — mainly due to tonearm resonance boosted surface irregularities from test record B & K QR 2011. The reference a 1/3 octave pink noise at 1 kHz has a level of —22 dB dB ref. 10 cm/s at 1 kHz



1,6 Hz Arm 1 1,25 kHz

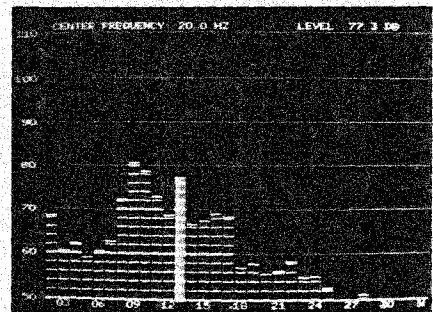

1,6 Hz Arm 2 1,25 kHz

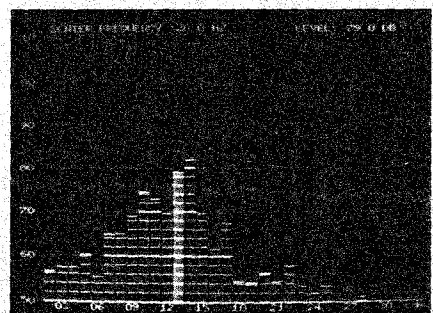

1,6 Hz Arm 3 1,25 kHz

Fig.12. Unweighted rumble spectra using three different arms in combination with one motor and cartridge. Test record B & K QR 2010 was used. 110 dB at the screen is the reference level 10 cm/s at 1 kHz

Wow and Flutter

When discussing turntable motors the prime parameter apart from rumble, seems to be speed stability. This is normally described in different ways depending on the frequency at which the speed changes. Deviations in the range 0 — 0,5Hz are called "drift" and is measured as an average over a certain period. Here the IEC standard (Ref.3) requires the use of a 30 s averaging time. When the frequency modulation is in the range 0,5 Hz to 10Hz it is called wow and from 10Hz to 100Hz flutter. But since the ear does not change sensitivity to frequency modulation very sharply at 10Hz there is in practice no reason for measuring them separately.

A very simple set-up for quantifying drift and wow and flutter is shown in Fig.14.

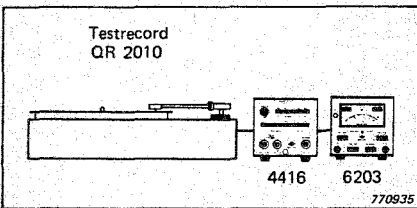

Fig.14. Set-up for measurement of drift and wow and flutter using B & K Type 6203 Automatic Flutter Meter and Test Record QR 2010. The stability of the recorded 3,15 Hz signal allows wow and flutter measurements down to $\pm 0,06\%$ weighted

In order to ensure a good correlation between the measured results and the degradation of the sound quality as judged by the ear, the weighting curve shown in Fig.15 should be used. Extensive listening experiments have shown that the ear is most sensitive to wow and flutter when the modulating frequency is around 4 Hz. Since it is the actual deviations from the original frequency, that is sensed by the ear, it is reasonable to use a \pm peak

| | Arm 1 | Arm2 | Arm 3 |
|--------------------------|--------------|--------------|--------------|
| Weighted wow and flutter | $\pm 0,04\%$ | $\pm 0,12\%$ | $\pm 0,06\%$ |

Table 2. Measured wow and flutter using the set-up in Fig.14. The same motor and cartridge was used with three different arms. The test record was B & K Type QR 2010

indication. In this case the greatest deviation in either positive and negative direction is reflected in the measurement. This makes the use of RMS detection less relevant when searching for optimum corre-

lation between measurable and audible evaluation. H. Saki (Ref.4) has found that the ear is able to detect as little as $\pm 0,06\%$ wow and flutter on a complex 5 kHz tone when the modulating frequency is 3 Hz.

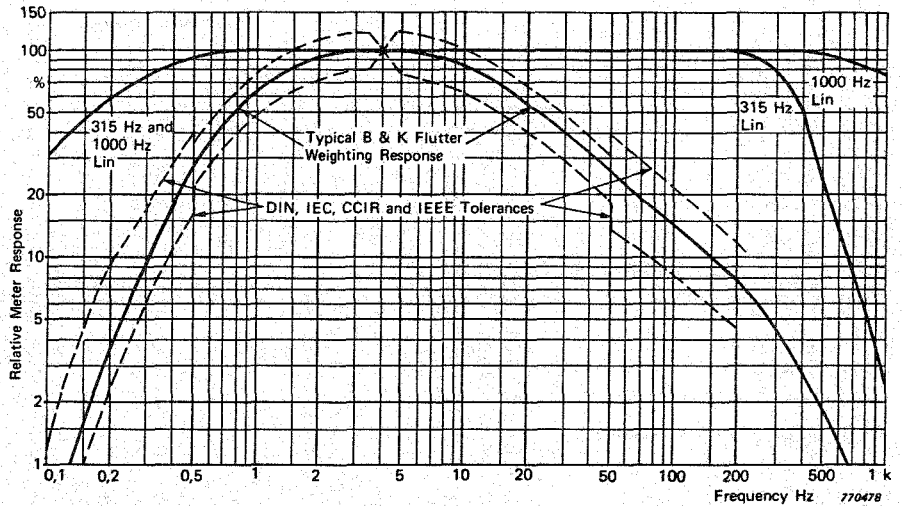

Fig.15. Three possible characteristics of the B & K Type 6203 Flutter Meter. The two marked Lin 315 and Lin 1000 are useful when making an analysis of the flutter spectrum (see Fig.15). The standardized weighting curve with its maximum at 4 Hz reflects the ear's sensitivity to wow and flutter as function of modulation frequency

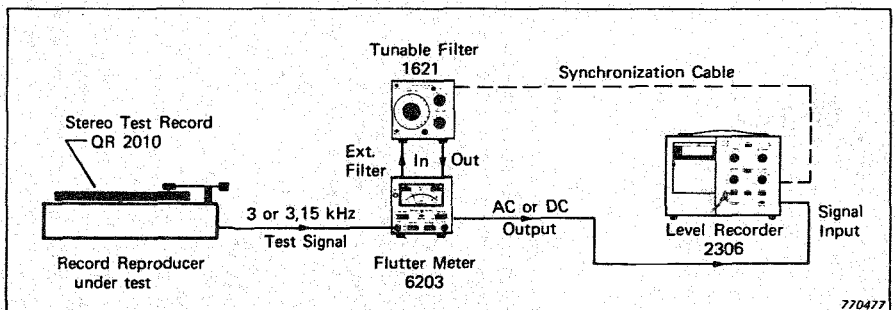

Fig.16. Instrument arrangement for third octave analysis of flutter

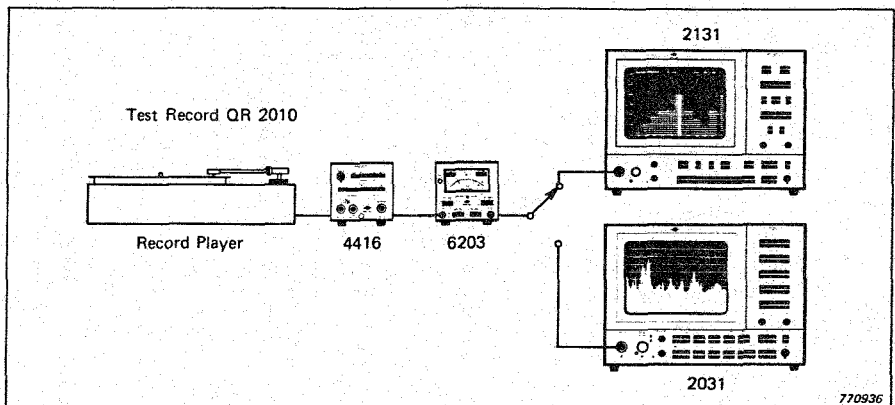

Fig.17. A sophisticated version for flutter analysis using B & K Type 2131 or B & K Type 2031

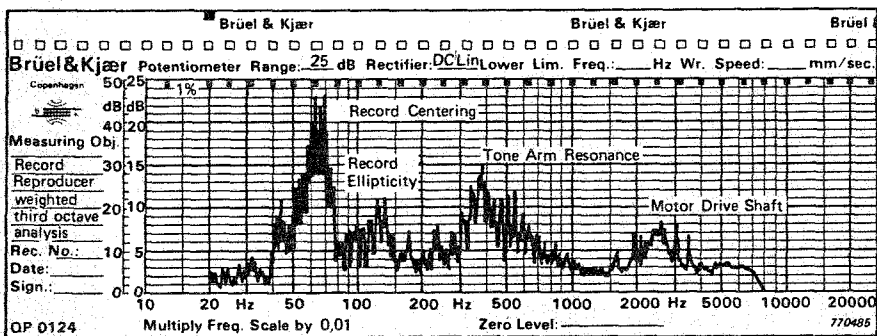

Fig.18. Typical result of a flutter analysis made with the set-up in Fig.16. A standard record player was used

Just like the measurement of rumble with A or B filters, as demonstrated in the last chapter, has very little to do with the quality of the turntable motor, one could ask: What does a wow and flutter figure read on the meter really tell about what it is supposed to — the motor.

The standardized measurement of wow and flutter was made on a turntable using three different tonearms. The results, listed in Table 2, show a great dependence

of the actual arm used. Has this anything to do with the tonearm resonance?

To answer this, one has to make a frequency analysis. A simple instrument arrangement for doing this is shown in Fig.16. A more sophisticated set-up in Fig.17 uses either B & K 1/3 Octave Analyzer 2131 or B & K Narrowband Analyzer 2031. Typical results from these measurements are shown in Figs.18 and 19.

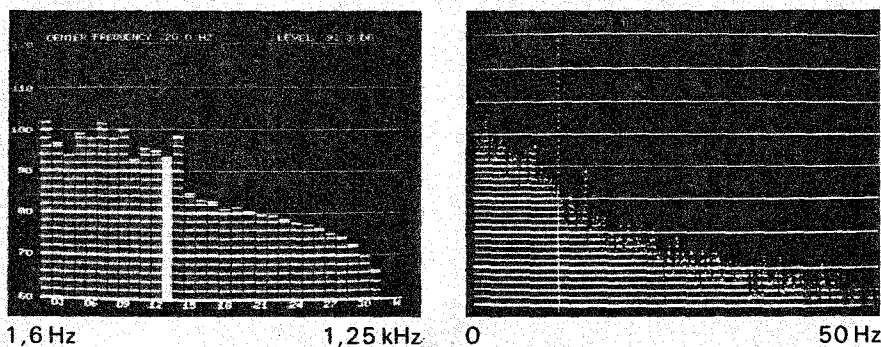

Fig.19. Weighted flutter spectra shown on Parallel Analyzers B & K Type 2131 and 2031. A medium quality turntable was used and the test record slightly worn

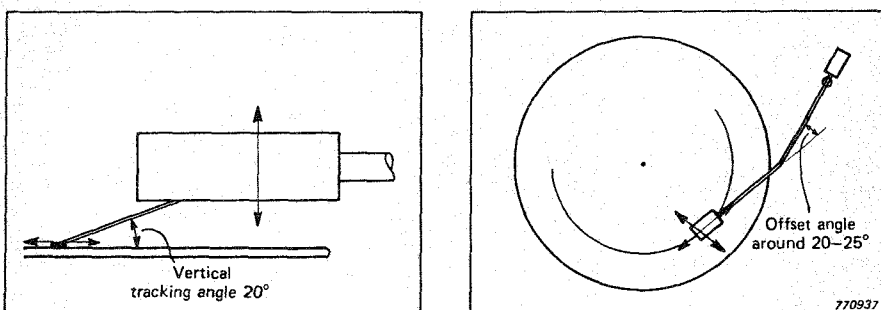

Fig.20. Left: Oscillations of the tonearm at the arm resonance in the vertical plane causes wow and flutter proportional to the vertical tracking angle
Right: Oscillations in the horizontal plane increases wow and flutter proportional to the offset angle. (Note that parallel tracking arms have an offset angle of zero degree and gives therefore superior wow specification)

A closer look at the spectrogram in Fig.18 clearly reveals four main causes of wow and flutter. The peaks at around 0,5 and 1,2 Hz are due to imperfections in the test record. The centring is a little off and the groove is not perfectly circular. Another important peak is seen at a frequency corresponding to the tonearm resonance, and therefore dependent on the chosen arm/cartridge combination. The last peak of importance, in this case at 25 Hz, is the only component that is related to the quality of the turntable motor.

This indicates that a single wow and flutter figure is very unreliable as a guide for the manufacturer who wants to improve his motor. It is also misleading to the consumer who buys his personal choice of arm and cartridge, since they strongly affect the amount of both measured and subjectively perceived flutter.

The situation is even more aggravated when adding the weighting function from Fig.15 to the analysis in Fig.18. It then becomes evident that the only really important parameter contributing to wow and flutter is the influence of the tonearm resonance. This once again puts the tonearm resonance in focus.

To see how the relative movements between the tonearm and record due to the resonance affect wow and flutter, one could look at Fig.20. Here we have shown how the vertical tracking angle for a cartridge, now standardized to 20° transforms vertical oscillations of the tonearm into needle movements along the groove, causing frequency modulation. In the same way the tonearm offset angle (usually around 20 — 25°) causes increased wow and flutter when the arm is oscillating in the horizontal plane. To illustrate this close link between the arm resonance and the measured wow and flutter we have shown the wow and flutter spectrum for the turntable fitted with the three different cartridge/arm combinations. See Fig.21. Apart from showing that the dominating lines in the flutter spectrum is closely related to the arm resonance(s) also the faults in the test record is seen to be important for the measured flutter value.

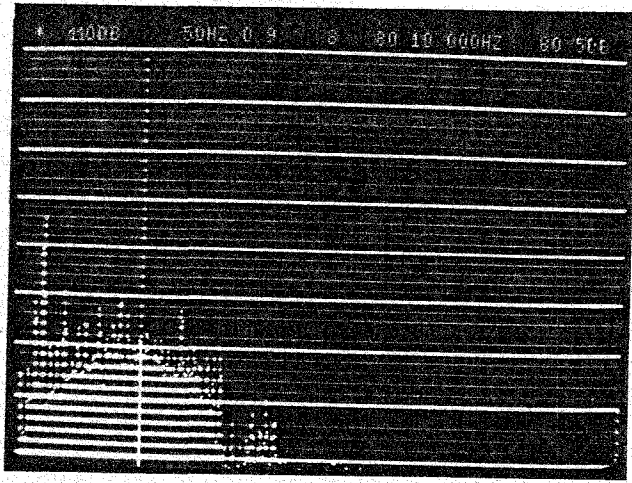

0 Arm 1 50Hz

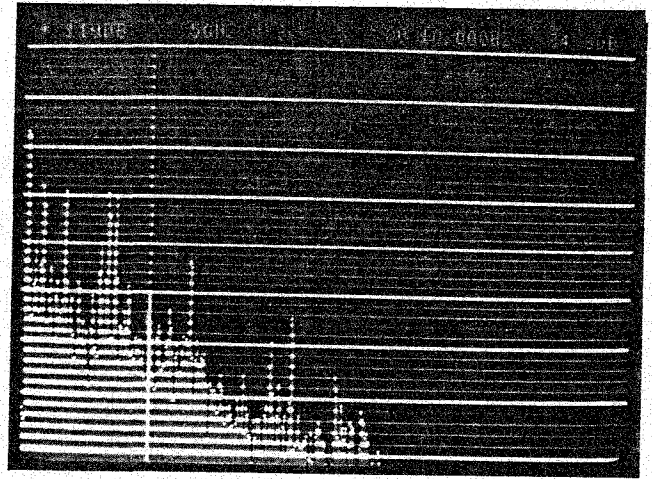

0 Arm 1 50Hz

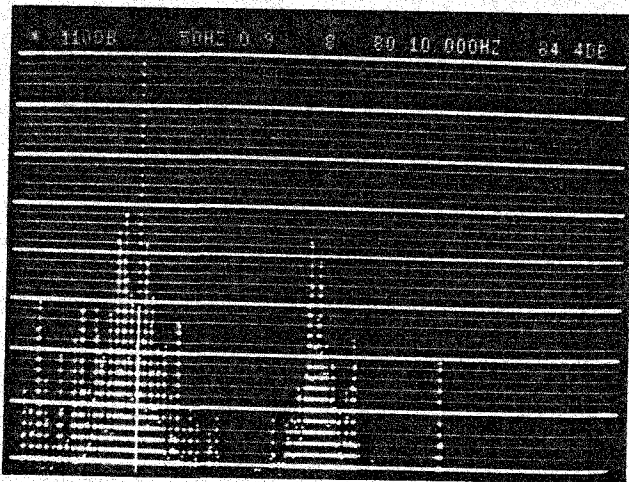

0 Arm 2 50Hz

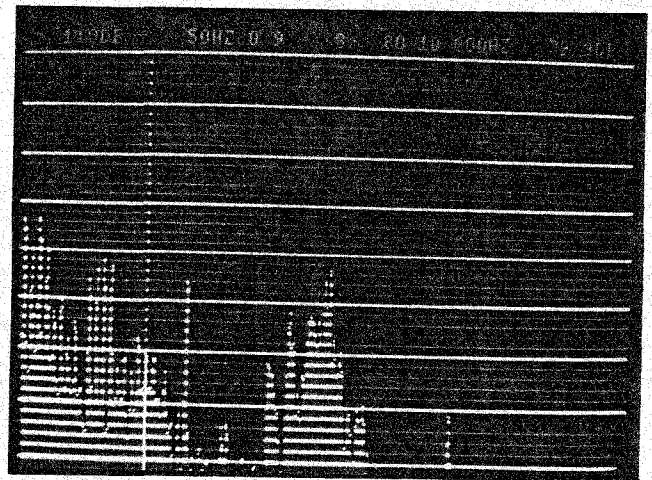

0 Arm 2 50Hz

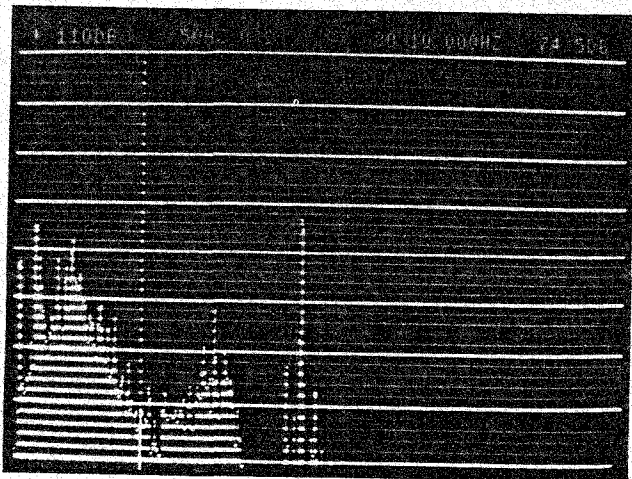

0 Arm 3 50Hz

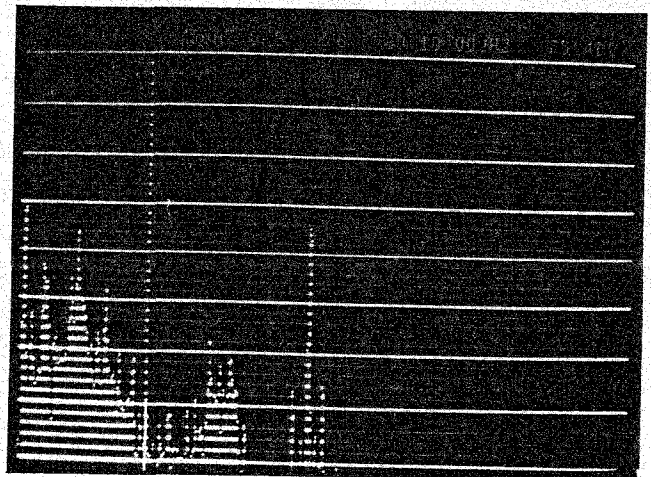

0 Arm 3 50Hz

Fig.21. Weighted wow and flutter spectra for a turntable fitted with three different arms. Two different test records were used B & K QR 2010 (right) and a Lacquer record (left). Dynamic range shown on screen is 40 dB

Especially arm number 2 indicates that a main part of the spectrum is covered with closely spaced lines. Shifting the 2031 analyzer frequency range to 0 — 10 Hz gave the result shown in Fig.22. From this, it is evident that the spectrum below 10 Hz totally is influenced by the eccentricity and irregularities of the test record. The fundamental frequency is around 0,55 Hz, but note the high level of 10 — 13th harmonic. Naturally it also appears as amplitude variations (rumble) but this time the fundamental 0,55 Hz and lower harmonics are filtered out by the frequency response of the arm/cartridge combination (see Fig.4).

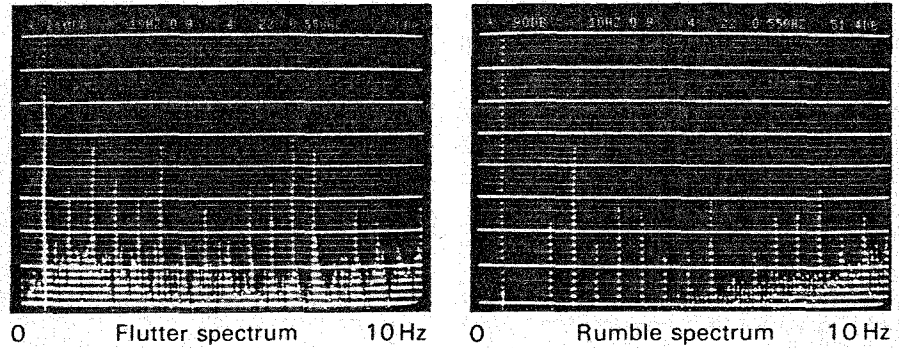

Fig.22. A closer look at the flutter and rumble spectrum reveals that record irregularities show up as discrete harmonic components. The fundamental frequency at 33 1/3 rpm is approx. 0,55 Hz. Note the high level and the 10 — 13th harmonic and compare with Fig.21. Test Record B & K QR 2011 and arm number 1 were used

Audible sidebands

In the two proceeding chapters we have discussed how the actual tonearm resonance affects the measured values of rumble and flutter. It is also pointed out that the audible effects of rumble and flutter are intermodulation which appears as sidebands on single tones. One could therefore try to look for a direct correlation between the arm resonance and the number and size of the sidebands. With the set up in Fig.9 is made a narrow band analysis of the playback of a 3 kHz tone. Three examples are shown in Fig.23 (note the arm/cartridge combinations here are not identical with any of those mentioned in Fig.4). The first (A) is the result measured with an arm/cartridge resonance of 7 Hz. In (B) the resonance is around 9,5 Hz and in (C) it has been put at 16 Hz and some damping applied. The lack of sidebands in (C) compared with (A) gives a clear improvement in sound quality in terms of increased stability and transparency in the stereo picture.

From this it is clear to see that to improve audible quality the main problem is to reduce the relative movements between cartridge and record as much as possible. In other words, one has to damp the arm resonance and move it upwards in frequency.

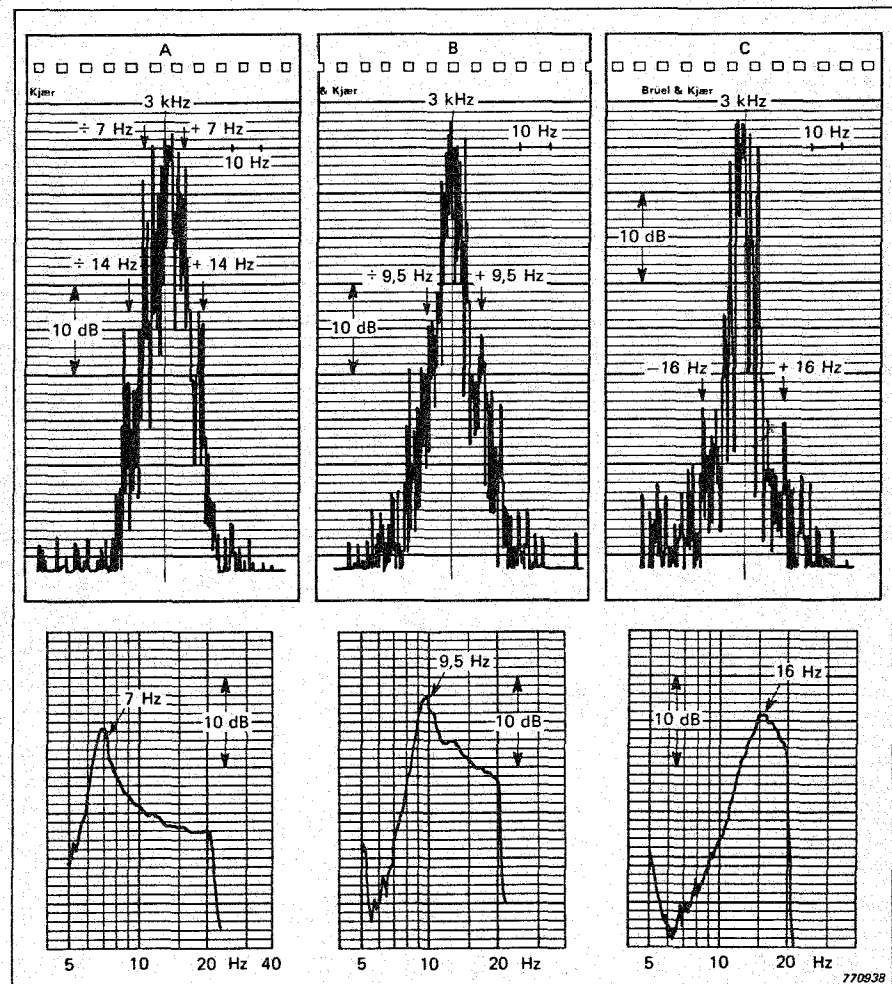

Fig.23. Narrowband analysis of a 3 kHz tone from three-arm/cartridge combinations with (A) undamped resonance at 7 Hz, (B) undamped resonance at 9,5 Hz and (C) damped resonance at 16 Hz. The corresponding plots of the tonearm resonance are shown below

Variations in tracking force

From Fig.12 it is evident that there are relative movements between the cartridge and record. These are larger the lower the resonance frequency and the less the damping. However, this implies to variations in the tension in the rubber suspension of the cartridge cantilever. This means variations in tracking force. To see how the frequency and damping of the tonearm resonance affect this in practice, we have made a couple of untraditional measurements.

The first is actually a transient test which makes use of a specially prepared record. With a hacksaw a tiny cut along the radius was made, enabling the two separated parts to be displaced about 0,2 mm. This leaves a step which sets the arm into oscillation when travelling across the notch (see Fig.24).

With this record we have tested the three arm/cartridge combinations also used in Figs.4 and 7. The results are shown in Fig.25. These curves were recorded on a storage oscilloscope, but the B & K Narrow-band Analyzer 2031 is also suited. In addition to the time response it can also give the frequency response. An example is shown in Fig.26.

This clearly illustrated the audible differences that can be heard between the various combinations. Here the sound quality, especially in the low frequency range, is greatly improved the faster the oscillations die out. The phenomenon is quite similar to what can be heard with loudspeakers where bass resonance shows different degrees of damping. It is common practise today in quality loudspeakers to have the bass resonance damped to a Q around 0,5 to 1,5. Why should tonearms not behave that well?

As mentioned, at resonance there are relative movements giving variations in tracking force. To get a more realistic view of these variations under practical playback conditions we fitted the three different arms with a strain gauge cartridge. The voltage from such a cartridge is directly proportional to the tension

in the suspension and tracking force. It was therefore possible directly to record on a storage oscilloscope the variations in tracking force during, e.g. two revolutions of

a record. The set-up is sketched in Fig.27. Some typical results are shown in Fig.28 using two different records. Number 1 having a medium sized warp at the beginning of

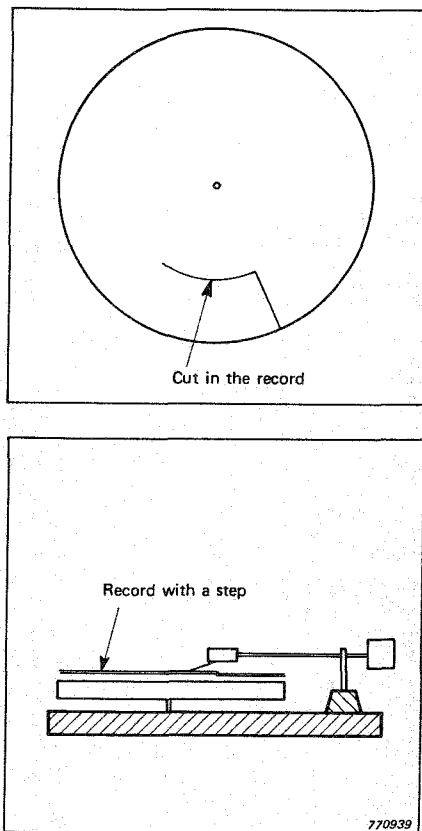

Fig.24. A small cut in a record enables the two parts to be displaced a bit. A well-defined step is then obtained for transient tests of cartridge/arm combinations

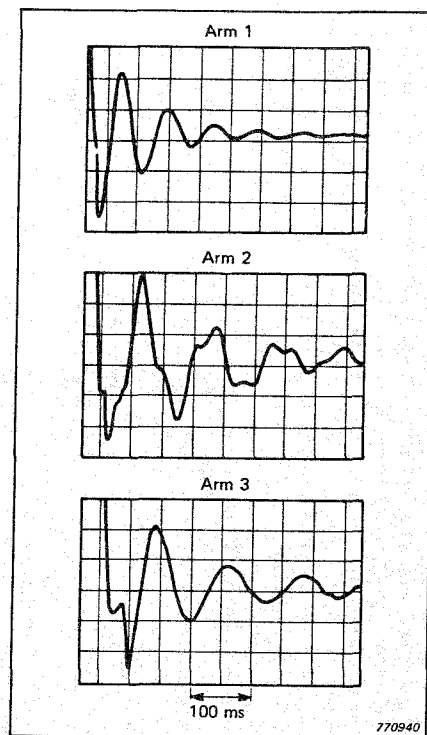
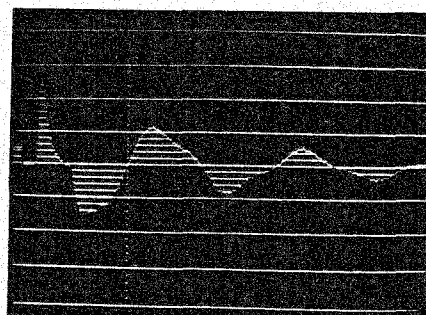
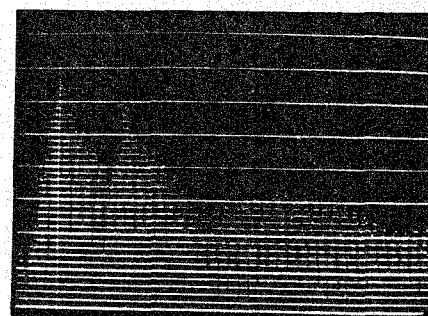

Fig.25. Oscillograms of the transient test using the record mentioned in Fig.24. Each picture shows the voltage from the cartridge reflecting the oscillations initiated by the step. As seen in most of the examples the oscillations continue for more than 0,5 s (1/4 revolution of the record)



0 Time response 312 ms



0 Frequency response 20 kHz

Fig.26. Time and frequency response of the transient test Fig.24 shown on B & K Type 2031. Tonearm number 2 was used

the record. Number 2 had no visible warps and was played at a radius of 8 cm.

The effect of this on the sound quality is evident. When looking a little closer to the oscillograms in Fig.28 it can be seen that in the case of arm nr. 3, the tracking force 20% of the time is below 5 mN (half of the preset value). It follows then that the cartridge is not able to track high frequencies without distortion for a considerable part of the total playback time. In this connection it could be mentioned that in a corresponding time interval the

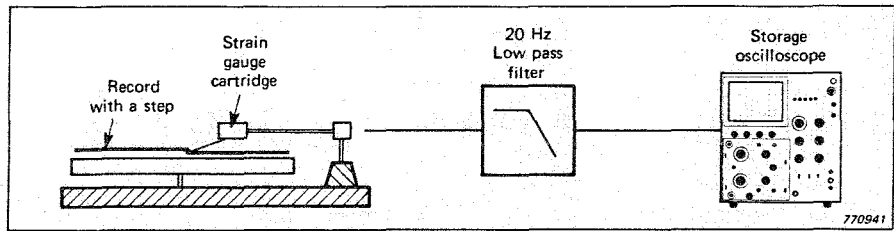

Fig.27. Set-up for recording the tracking force variations during play-back of ordinary records

tracking force is far above what it is supposed to be with possible acceleration of record wear.

The actual increase in distortion due to mistracking is illustrated in

Fig.29. Here we have shown on the B & K Type 2131 1/3 Octave Analyzer, the distortion from the playback of a 1/3 octave pink noise at 20 kHz (from test record B & K OP 2011).

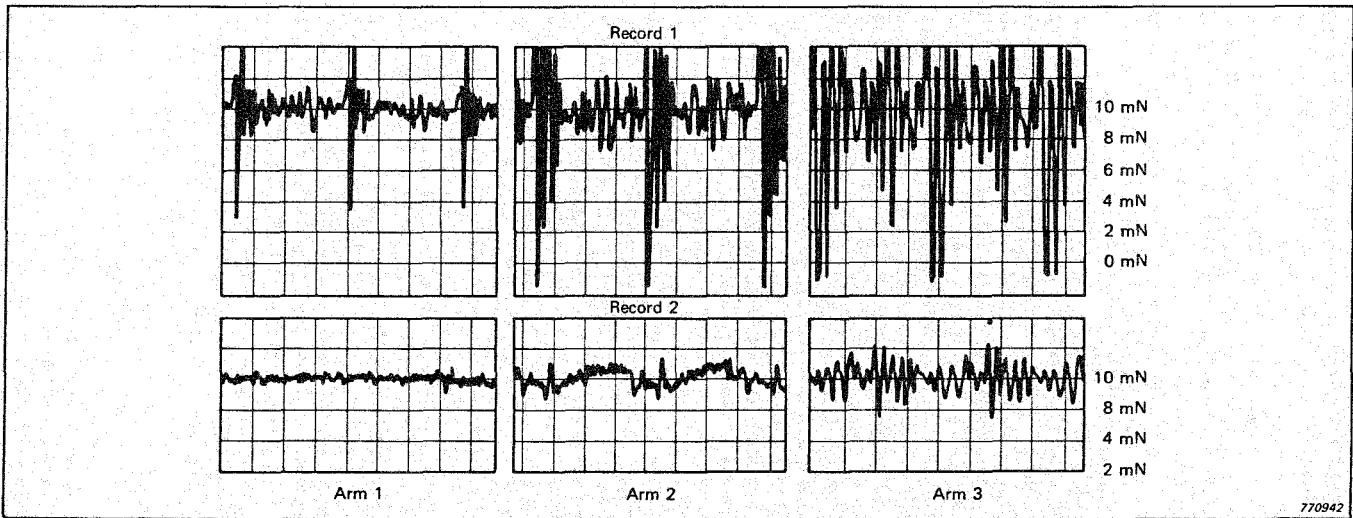

Fig.28. Tracking force variations during playback of two average records. The pictures show a period of two revolutions of the record and the vertical scale is calibrated directly in mN. The initial set tracking force was adjusted to 10 mN. In this test the most lightweight arm (number 1) clearly outperforms the other two

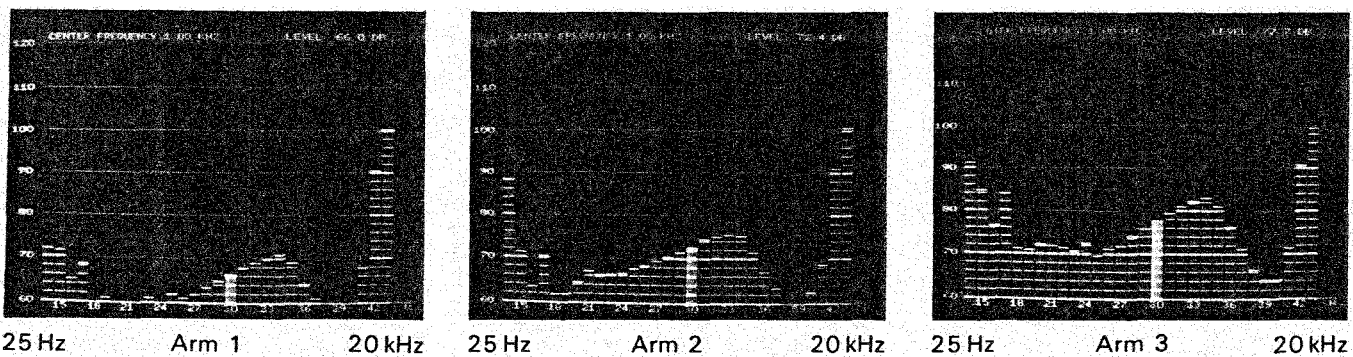

Fig.29. Increase in distortion due to mistracking using the same cartridge in three different arms. The signal is a 1/3 octave pink noise at 20 kHz recorded at -22 dB ref. 10 cm/s at 1 kHz (from test record QR 2011)

BIM (Bass Intermodulation)

As shown in the text above, the direct consequences of a turntable showing a resonant frequency response below 20 Hz is rather unimportant. It is normally only detected in connection with vented loudspeaker enclosures as large low frequency excursions. To cure this, the switching in of a rumble filter — a high pass filter with a steep cut-off below 25 — 40 Hz — is perfectly adequate.

As regards the indirect consequences, the situation is much worse. It seriously affects both the measured and audible rumble and wow and flutter from turntables, making standard, one figure "statements of turntable quality" doubtful. At least it has very little to do with the actual rumble and wow and flutter originating from the motor. The strong influence on these by the actual tonearm/cartridge resonant frequency tells that unless the measurements are accompanied with specified arm and cartridge they are of no value.

Furthermore, the results shown clearly indicate that it is the fre-

quency and the damping of the tonearm resonance that really count. For years it has been known that wow and flutter — low frequency modulation — folds up in the audible range as sidebands to the tones there. The result is similar from the amplitude intermodulation due to rubber suspension and preamplifier nonlinearities. We have also shown how a "scratch" (transient) in the record sets the arm into oscillation at the tonearm resonance giving coloration to the sound.

In Fig.30 is shown another striking example of how closely amplitude and frequency variations are linked together in the range below 20 Hz giving distortion in the audible band. Here is shown a rumble and flutter analysis of a turntable with a pronounced tonearm resonance at 7 Hz. In addition there are wow and flutter components at 20, 40 and 80 Hz.

Lastly we demonstrated the influence on tracking force giving distortion in the midrange during playback of high frequencies.

As a parallel to the now widely used term TIM (Transient Intermodulation Distortion) which indicates the distortion components falling into the audible band when high level and high frequency (out of band) signals are fed to a feed-back amplifier — we could introduce the word BIM (Ref.5). Bass Intermodulation — a result of a high level low frequency (out of band) signals from a record boosted by an undamped tonearm resonance.

The last conclusion we can draw from these investigations is the means of avoiding BIM. Since we have to accept that practical records (Ref.2) contain a large amount of "rubbish" centred around 4 — 5 Hz including warps, the optimum solution is clear. The tonearm/cartridge resonance has to be placed at such a high frequency 13 — 18 Hz that it mechanically filters out the subsonic signals. In addition some damping should be applied to eliminate oscillations and influence on the frequency response above 20 Hz.

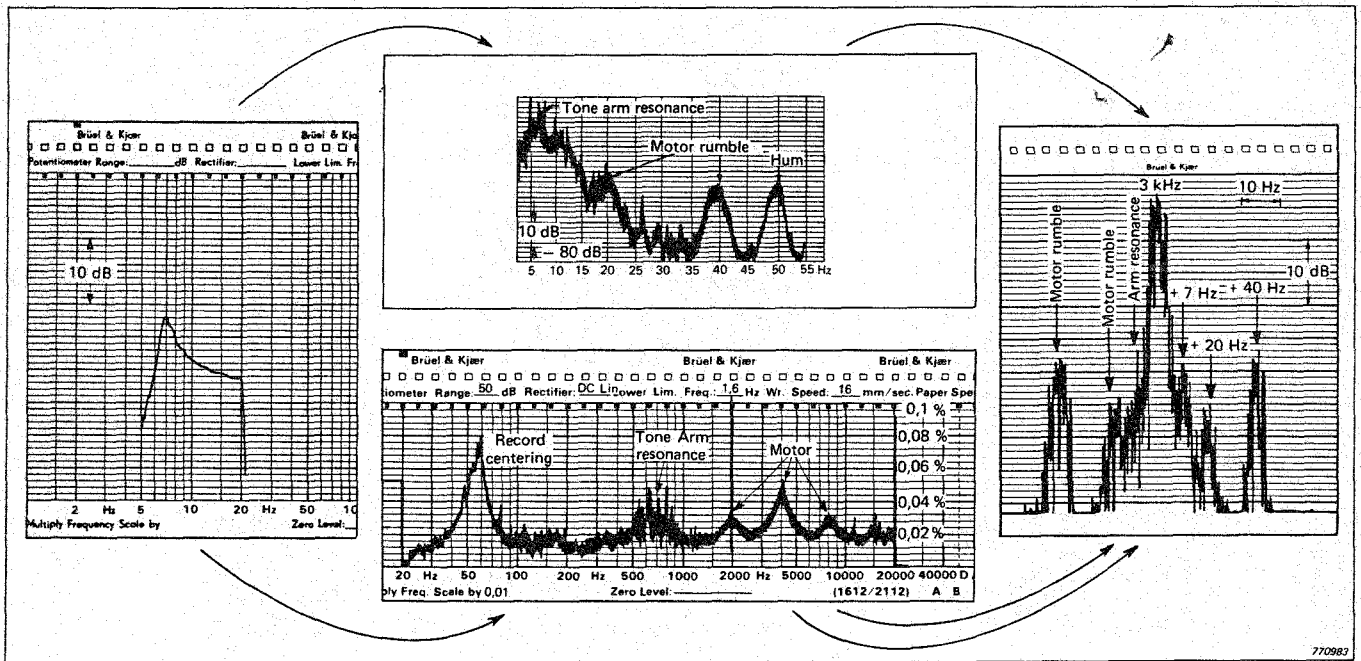

Fig.30. Subsonic amplitude and frequency intermodulation results in distortion in the audible band. Here in the form of sidebands added to a pure sine at 3 kHz.

Part II

Resonances in the tonearm itself

From Part 1 it follows that a possible way of improving the performance of a turntable is an increase in the resonant frequency of the arm/cartridge. This means that either the compliance of the cartridge, its weight or the effective mass of the arm have to be decreased. The compliance, however, cannot be lowered without requiring an increase in tracking force. The cartridge weight is closely related to, and a function of its construction. This leaves a reduction of the effective mass of the arm as the practical solution. However, it also has drawbacks. A more lightweight construction is more susceptible to flex. These flexings in the arm result in peaks and dips in the frequency response (see Fig.31). Here the results are listed from one cartridge in combination with three different arms. As the B & K 2011 test record is used it has a slow sweep (lateral cut 20 — 1000Hz, 50s/decade). This allows all resonances to build up to their full size. We have recorded results from both right and left channels. When the flexings show up "in phase" it indicates bendings in the vertical plane and "out of phase" shows bending in the horizontal plane.

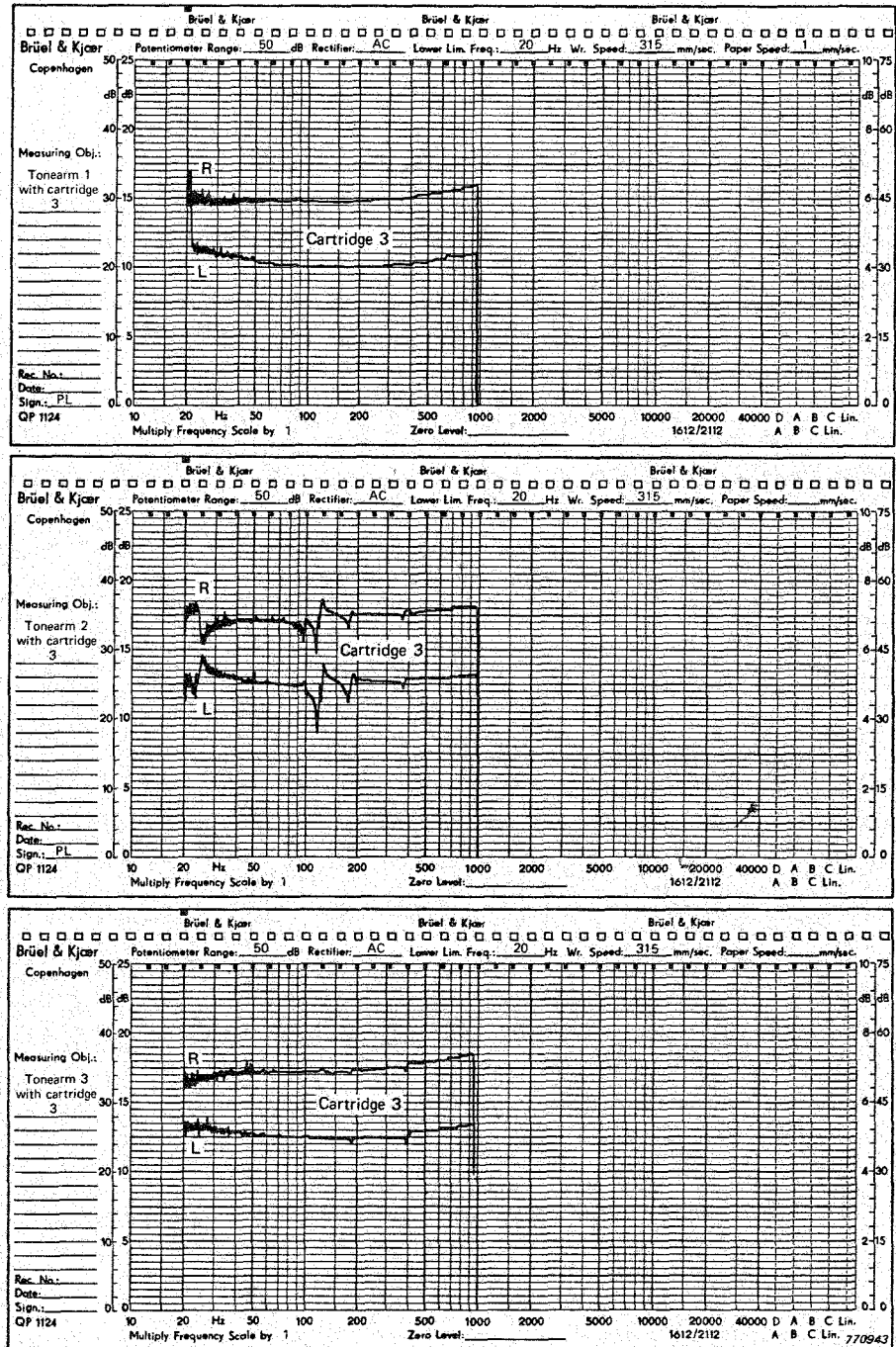

Fig.31. A slow sweep from 20 — 1000 Hz, using B & K Type 2011 test record, reveals flexing in the tonearm itself. The same cartridge and turntable was used

Acoustical and mechanical feedback

As already indicated in Fig.1, a turntable can be described as a number of completely stiff mechanical parts linked together with compliances. This leaves a great number of different resonant modes possible. To excite these and cause relative movements between the record and cartridge body not only the vibrations due to the information in the record groove should be considered. When loudspeakers are used for playback both the airborne and structure borne vibrations from the speaker should be taken into account. Long before the system goes into oscillation audible coloration of the sound is unavoidable. To give a qualitative view of this we tried the set-up shown in Fig.32. As a reference the spectrum (Fig.33) is the acoustical response from the loudspeaker with the microphone at the arm position. With equidistant posi-

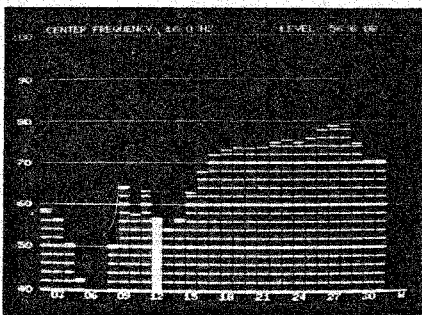

Fig.32a. Acoustical response from the loudspeaker measured at the cartridge position

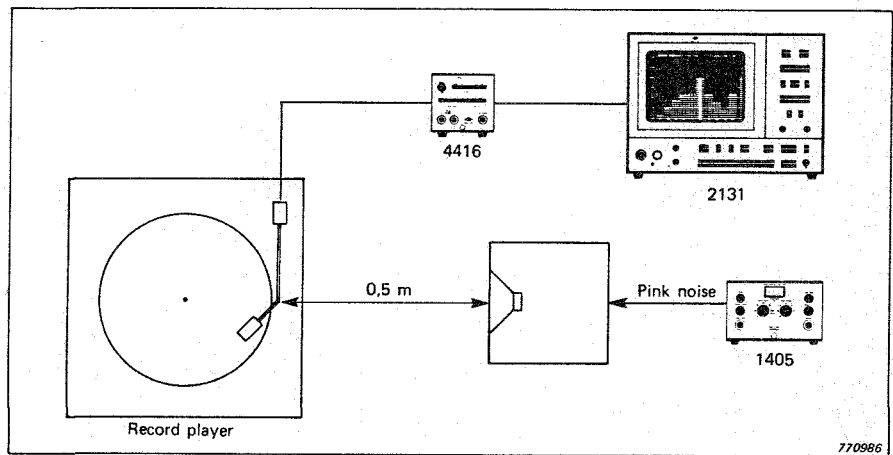
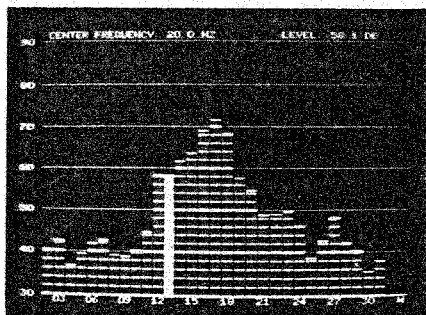

Fig.32. Measurement of the resonance modes in a turntable, when exposed to mixed acoustical-mechanical excitement. The signal fed to the loudspeaker is broadband pink noise

tions for the three arms relative to the loudspeaker we measured up the following three spectra shown in Fig.34. Here the stylus was resting on a non-rotating record and pink noise fed to the loudspeaker. As seen, the three arms exhibit a marked difference in sensitivity to this mixed acoustical-mechanical excitation.

A more detailed study of these resonances was then done with the Narrowband Analyzer Type 2031. The spectra from arm 1 and 3 were read out on a Level Recorder Type 2307 (see Fig.35). This indicates that only the resonances around 35 Hz seem to originate from the turntable itself. The others must originate from resonances in the two arms. The relatively small ampli-

tudes of these resonances in the turntable and arm tube make it difficult to make direct correlation with the subjective listening results. However, one must realize that these resonances build up when hit by transients in the music, either direct from the groove or indirect via the loudspeaker. When the transient is gone the resonances deliver their stored energy back to the cartridge and is now converted to electrical signals at a time where there should be no signal. The phenomenon is directly comparable to what in connection with loudspeakers is called "Early reflections or box sound" (Ref.6). The importance of a reduction of panel vibrations and its effect on sound quality has been known for years.



1,6 Hz Arm 1 1,25 kHz

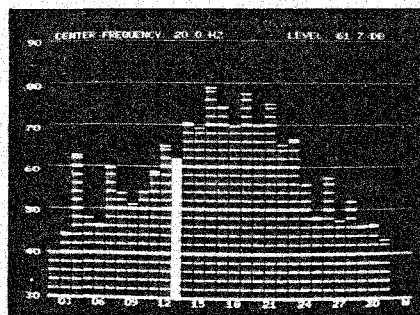

1,6 Hz Arm 2 1,25 kHz

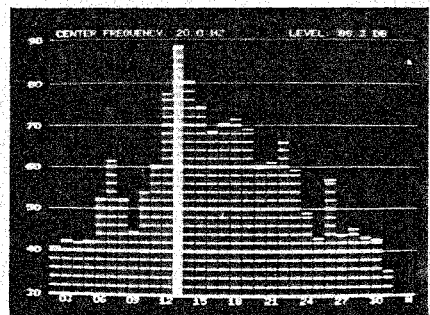

1,6 Hz Arm 3 1,25 kHz

Fig.34. Spectra from the three different arms with the cartridge resting on a non-rotating record when exposed to broadband pink noise. Set up: see Fig.32

As regards turntables very little has been done yet. However, our listening test has shown there is a clear preference for arm number 1 in this respect. In addition it is supported by the quantitative measurements shown.

One possible way of establishing a measurement method that could give more quantitative results could be the use of recorded tone burst signals. When measuring the signal level between the bursts one could get an idea of the size and frequency of these spurious resonances, (Ref. 6 and 7).

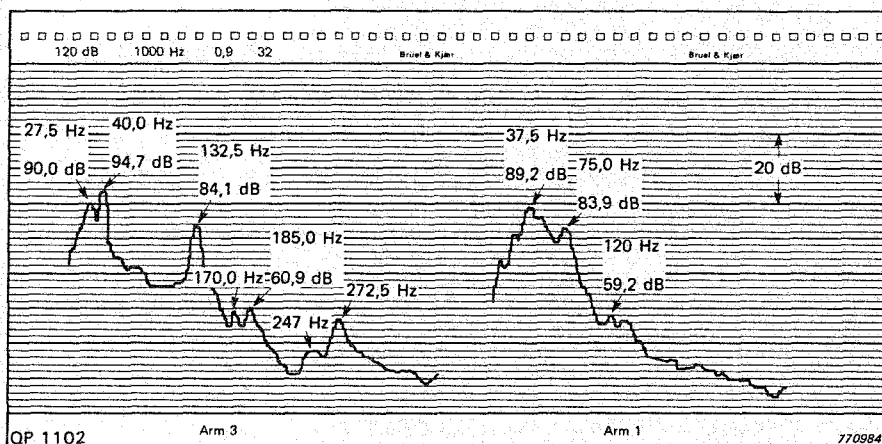

Fig.35. Frequency and level of resonant modes in a turntable with two different arms

Conclusion

In this paper we have pointed out that traditional specifications like rumble, wow and flutter and required tracking force are both unreliable and inadequate. Furthermore, they are strongly influenced by the actual combination of motor, arm, cartridge and record, all of which are often left to random decisions by the Hi-Fi consumer. By the use of modern test equipment we have tried to throw a little light on the causes and influence of the interface problems between the elements in a turntable. Assisted by listening tests one can conclude that

the fundamental problem creating parameter is the frequency response of the turntable below 20 Hz. Most modern turntables leave much to be desired, typically they have resonance peaks of 5 — 10 dB at 5 — 7 Hz. The first thing to do is to raise the frequency to 15 — 18 Hz and then ideally damp the system to a Q of 0,5, letting response roll off at preferably 12 dB/oct.

In pursuit of this goal one should not make trade offs with respect to rigidity of the tonearm tube and fix-

ture. Flexing in the arm and other spurious resonances could then be the result and destroy the stability of the stereo image.

Finally in Part 2 we have focused on a type of distortion that is most clearly seen in the time domain: Early reflections. Our investigation tells us that here is an area which, at present, has rather poor correlation between the measurement methods available and the impact on the sound quality.

References

1. Peter Rother: "The aspects of low-inertia tonearm design" J. Audio Eng. Soc., Vol. 25 pp 550—559, (Sept. 1977)
2. L. Happ and F. Karlov: "Record warps and System Playback performance", presented September 10, 1973 at the 46th Convention of the Audio Engineering Society, New York
3. IEC Publication 386 (1972) Method of measurement of speed fluctuations in sound recording and reproducing equipment
4. H. Saki (1970) Perceptibility of Wow and Flutter JAES vol. 18 pp 290—298
5. Henning Møller "Multidimensional audio", presented Nov. 1977 at the 58th Convention of the Audio Engineering Society, New York B & K Application Note 17—206
6. Henning Møller 3-Dimensional acoustic measurements — using gating techniques AES paper New York 1977 and B & K Application Note 17—163
7. Henning Møller and Carsten Thomsen Electro Acoustic free-field measurements in ordinary rooms — using gating techniques AES paper New York 1975 or B & K Application Note 17—196
8. Henning Møller Electro Acoustic Measurements B & K 16—035